

Zweeds loopspel
amtrek,
oppervlakte en
inhoud



Organisatie

Hang de kaartjes ergens verspreid op, bijvoorbeeld buiten op het schoolplein. De leerlingen krijgen elk een antwoordblad. Ze kunnen de kaartjes aflopen op volgorde of random. Dat is wat je afspreekt met de leerlingen. Ze lezen de som, rekenen dit uit en schrijven het antwoord op.

Nakijken kan door het antwoordblad of plenair in de klas.

Benodigheden

- **Uitgeknipte kaartjes**
- **Voor elke leerling een werkblad**



1. Wat is de oppervlakte van dit figuur?

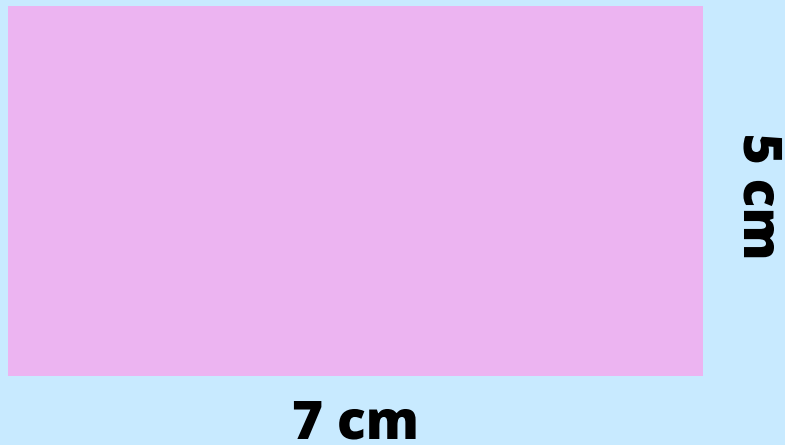

2. Wat is de omtrek van dit figuur?

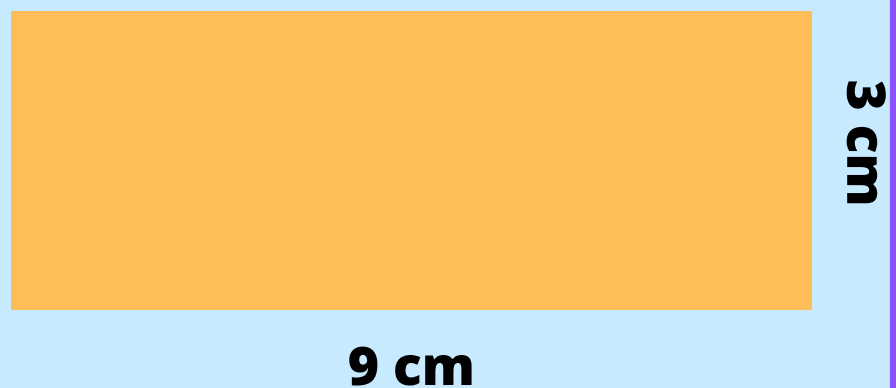

3. Wat is de oppervlakte van dit figuur?

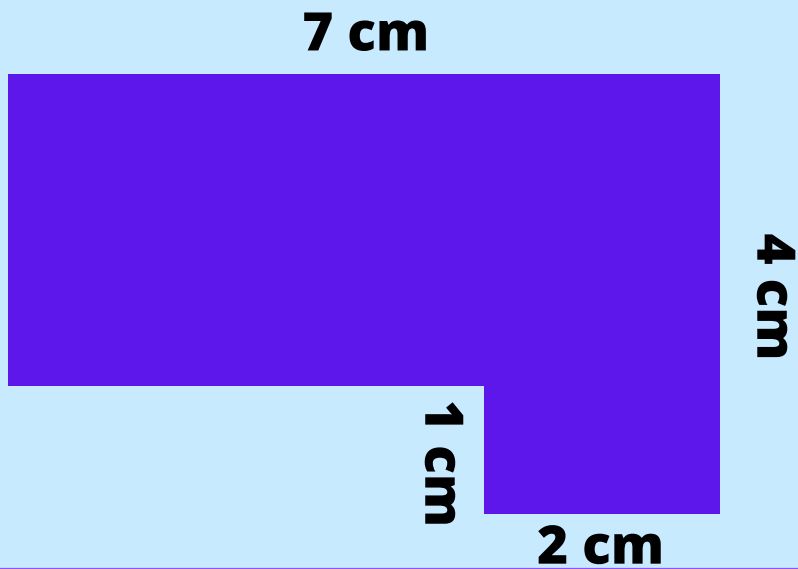

4. Wat is de omtrek van dit figuur?

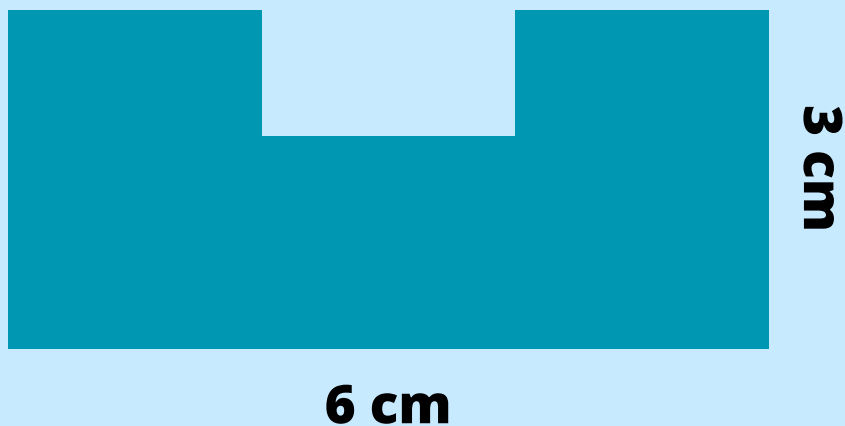

5. Wat is de oppervlakte van dit figuur?

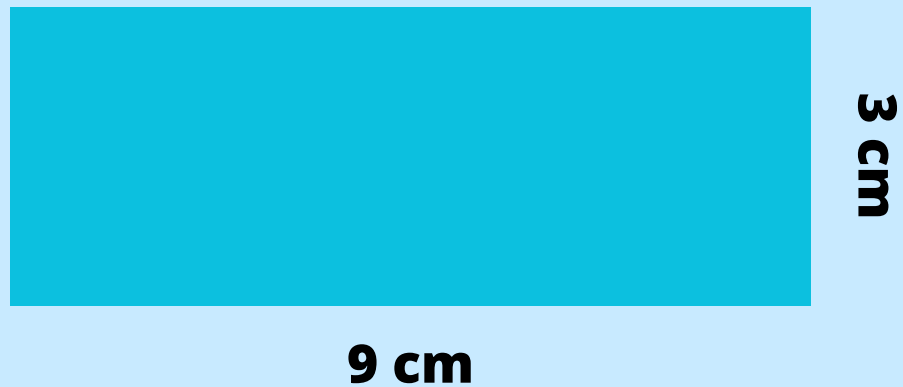

6. Wat is de omtrek van dit figuur?



7. Wat is de oppervlakte van dit figuur?

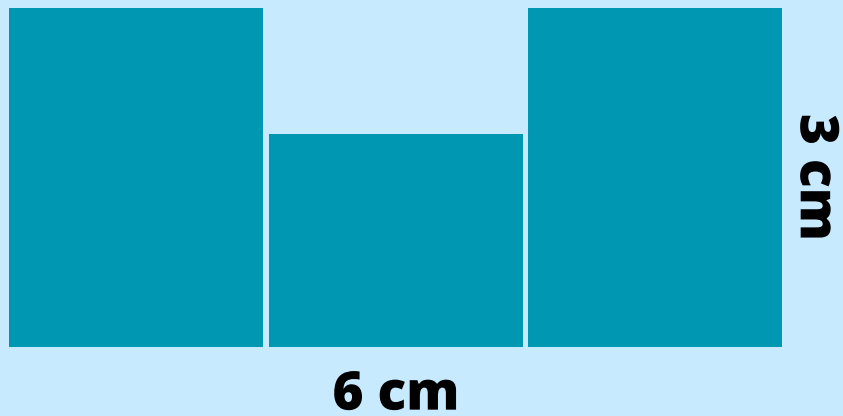

8. Wat is de omtrek van dit figuur?

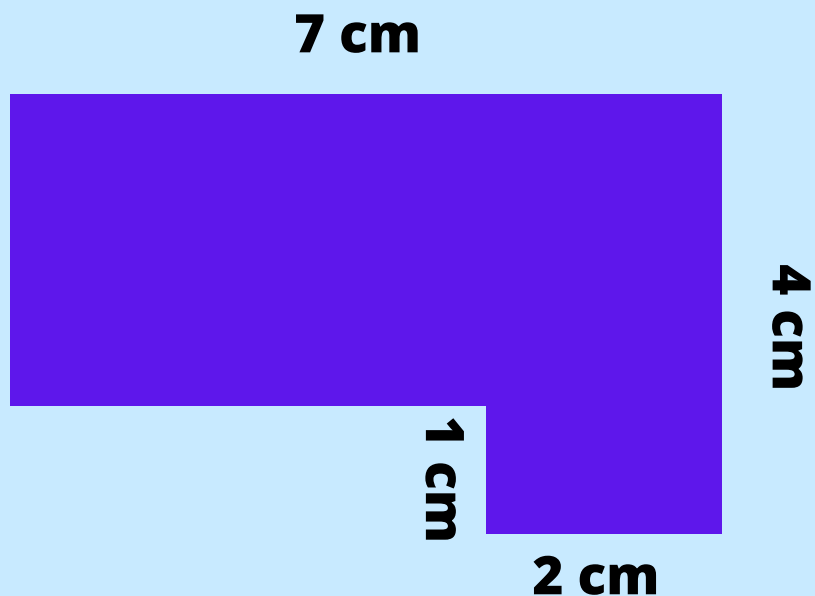

9. Wat is de oppervlakte van dit figuur?

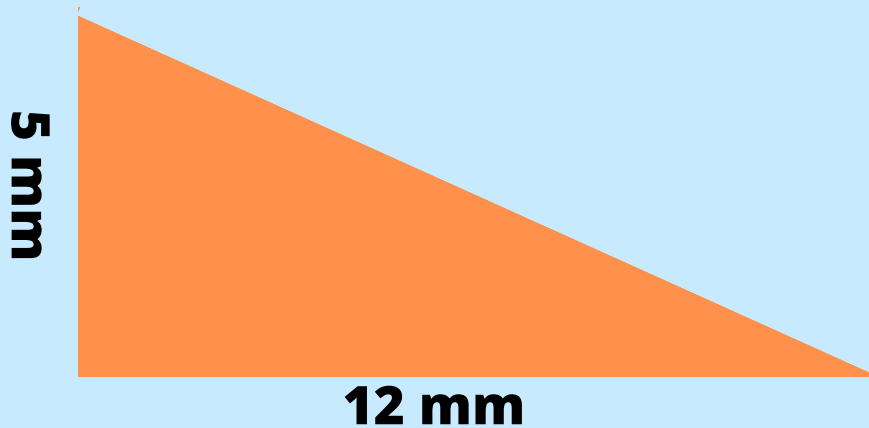

10. Wat is de oppervlakte van dit figuur?

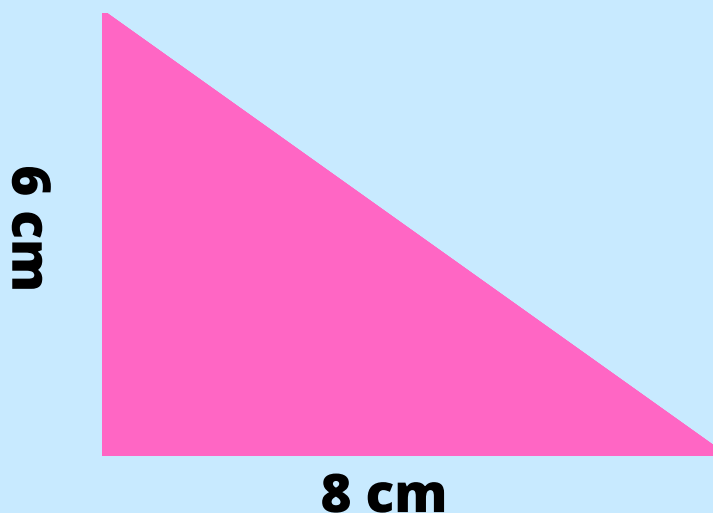

11. Wat is de oppervlakte van dit figuur?

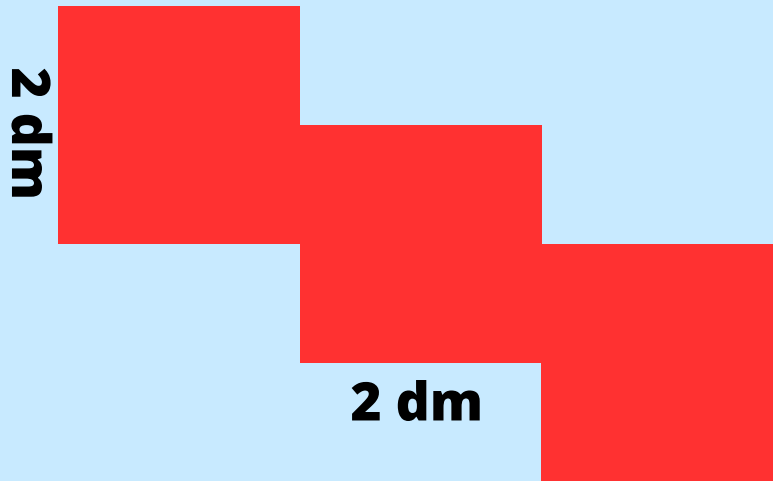

12. Wat is de omtrek van dit figuur?

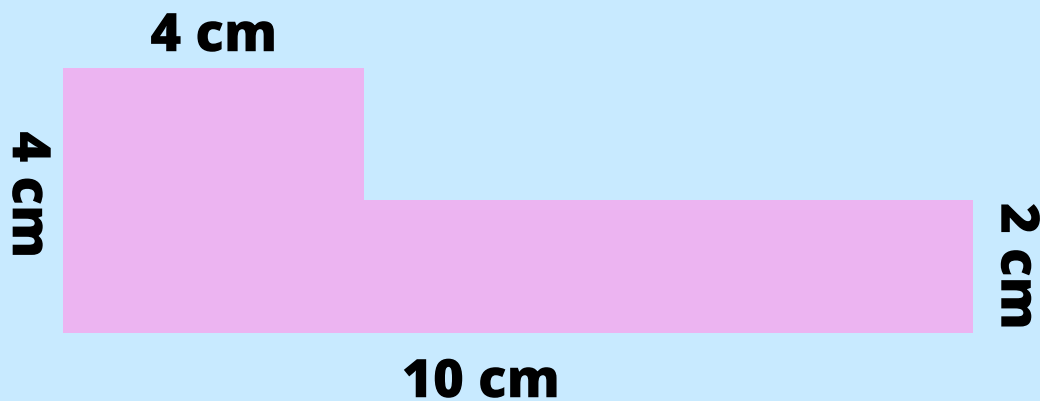

13. Wat is de oppervlakte van dit figuur?

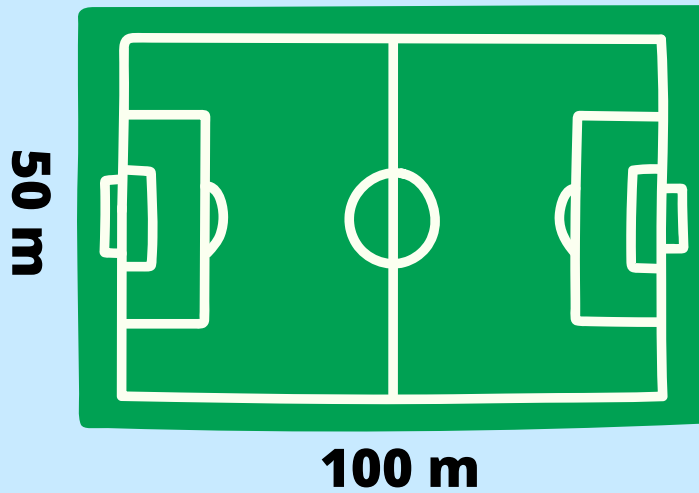

14. Wat is de omtrek van dit figuur?

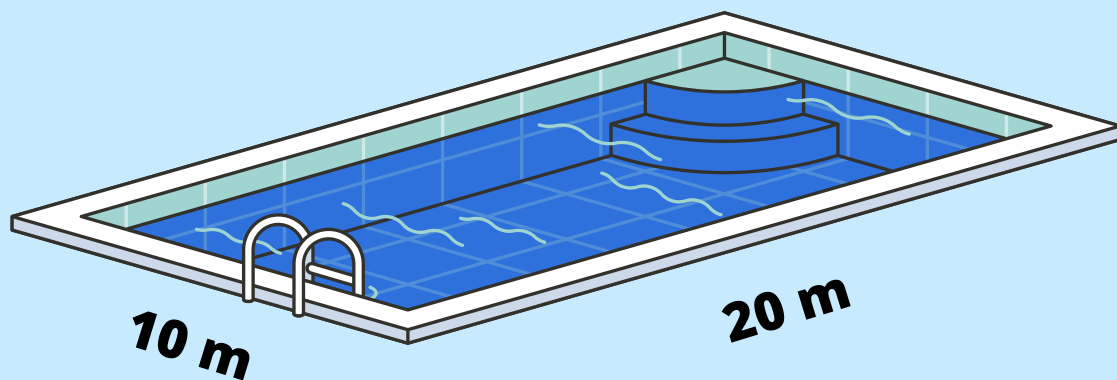

15. Wat is de oppervlakte van dit figuur?

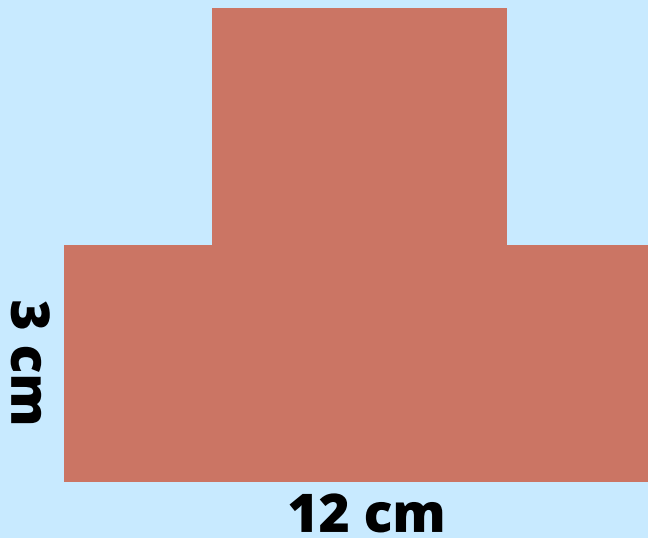

16. Wat is de omtrek van dit figuur?

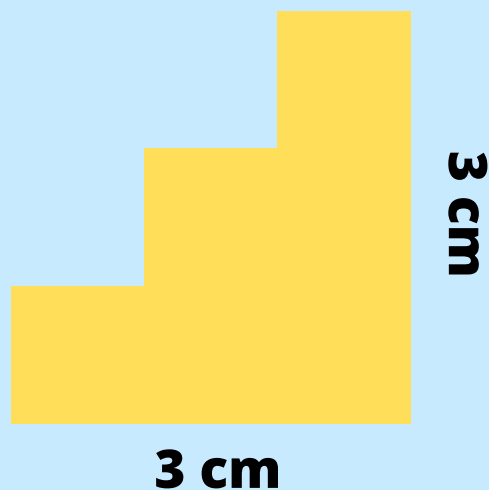

17. Wat is de oppervlakte van dit figuur?

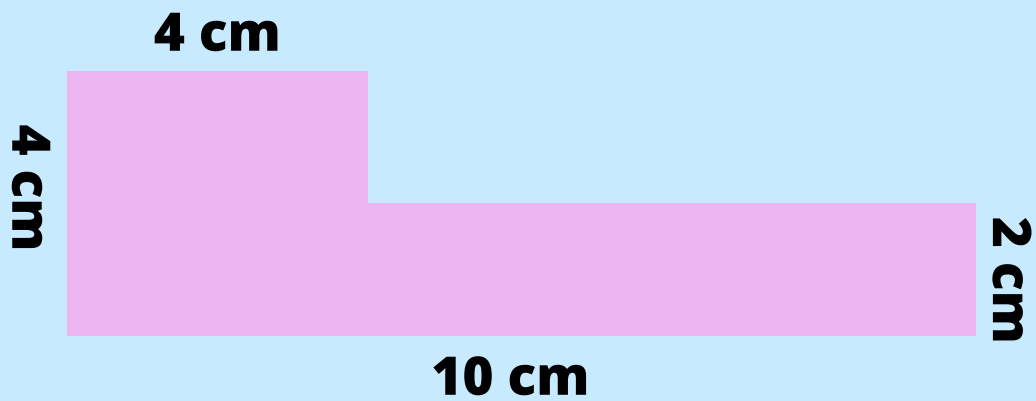

18. Wat is de omtrek van dit figuur?

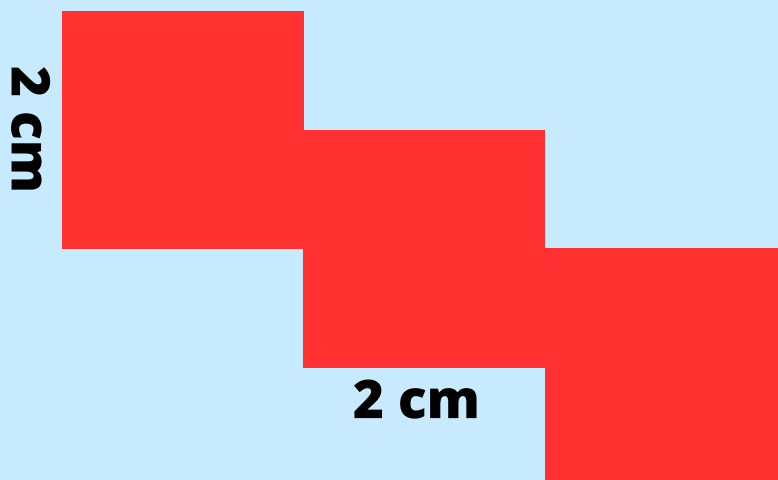

19. Wat is de oppervlakte van dit figuur?

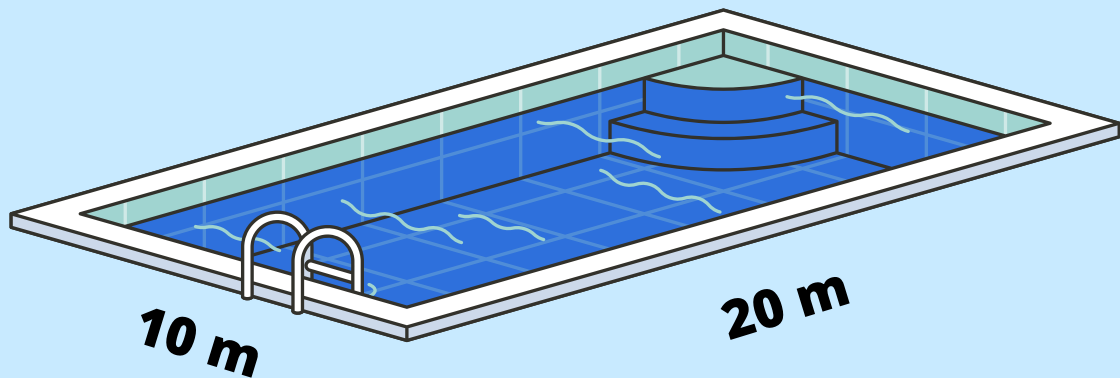

20. Wat is de omtrek van dit figuur?

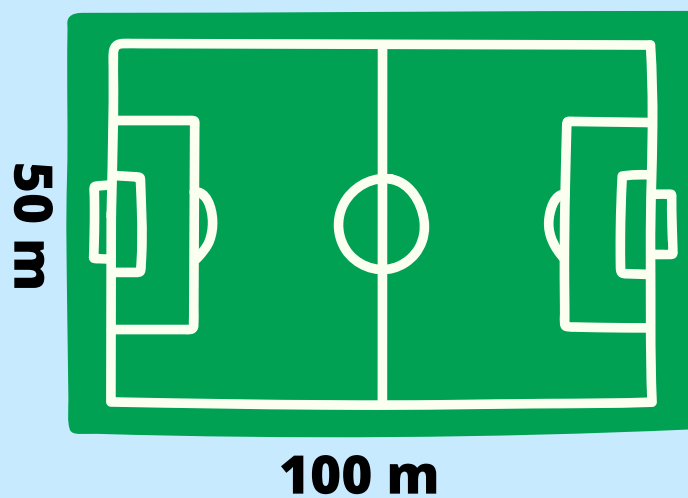

21. Wat is de inhoud van dit figuur?

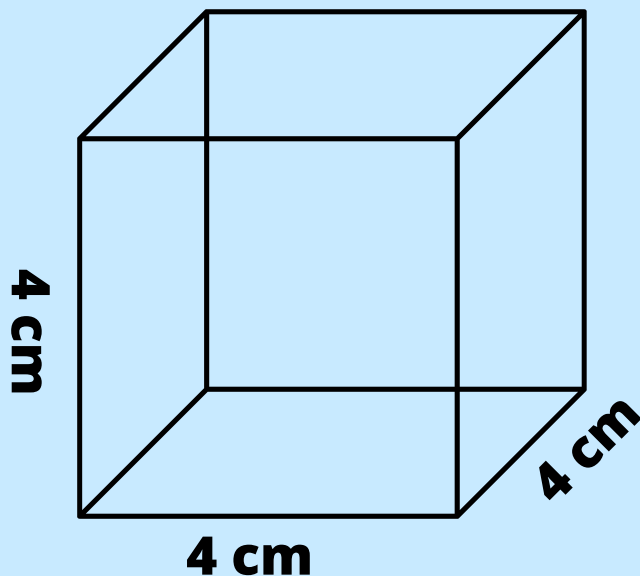

22. Wat is de inhoud van dit figuur?

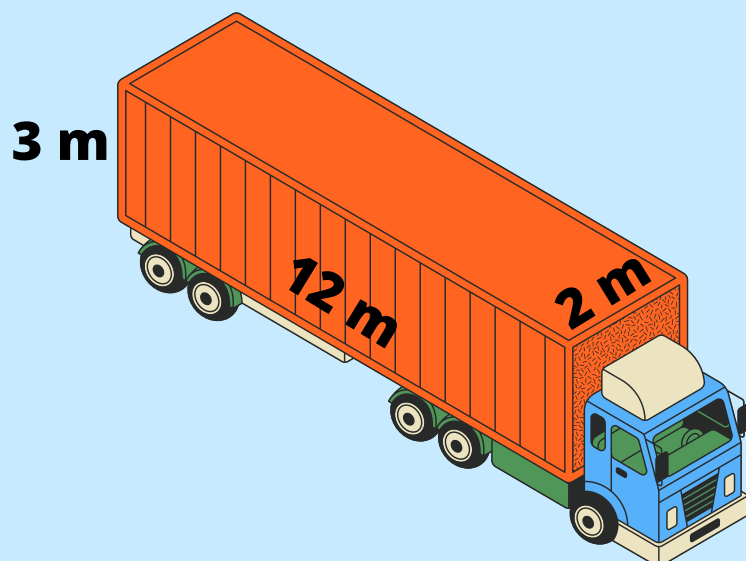

23. Wat is de inhoud van dit figuur?

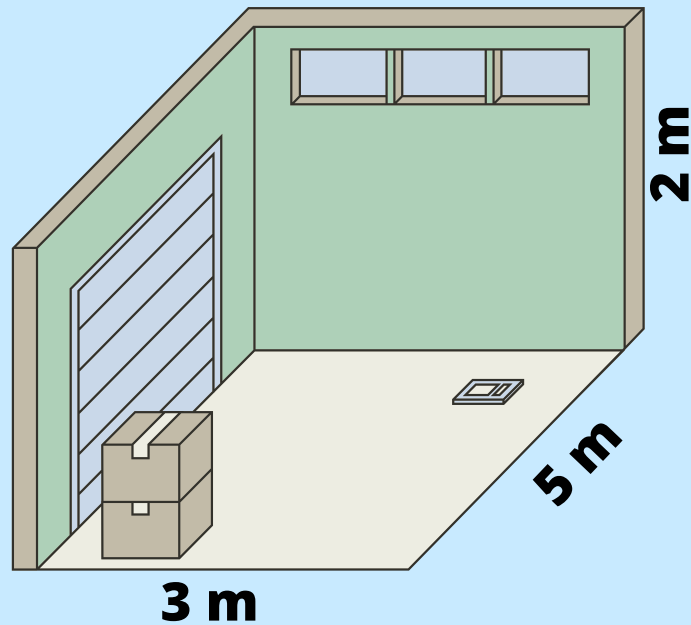

24. Wat is de inhoud van dit figuur?

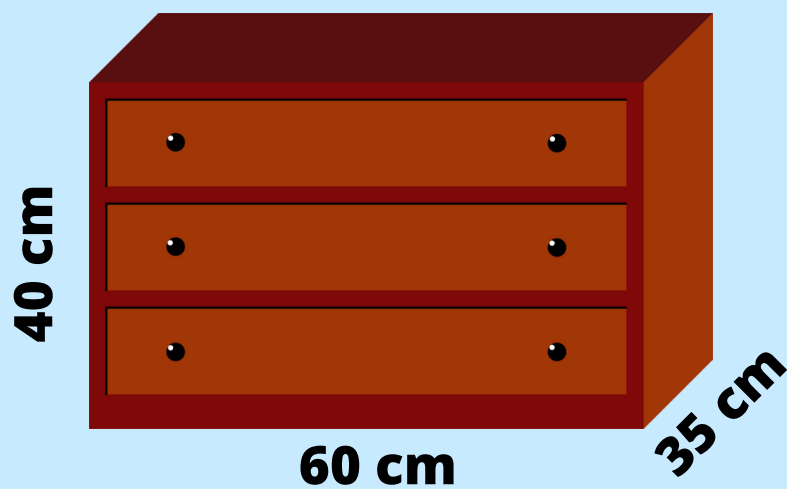

25. Wat is de inhoud van dit figuur?

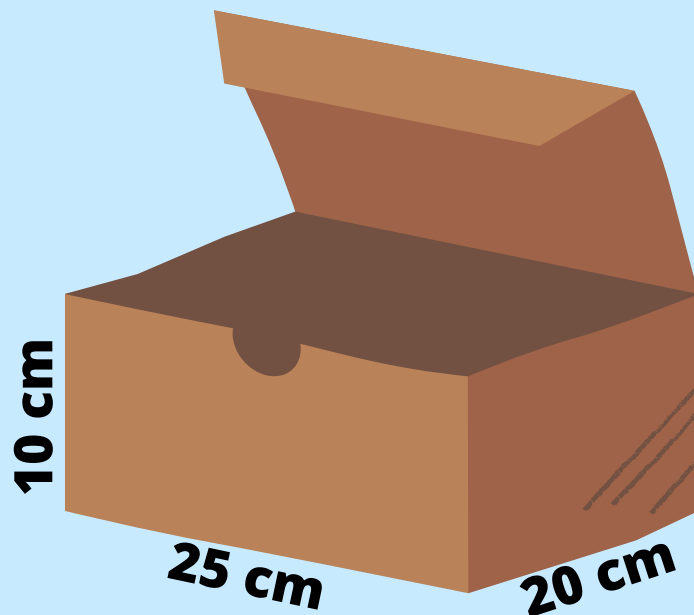

26. Wat is de inhoud van dit figuur?



27. Wat is de inhoud van dit figuur?

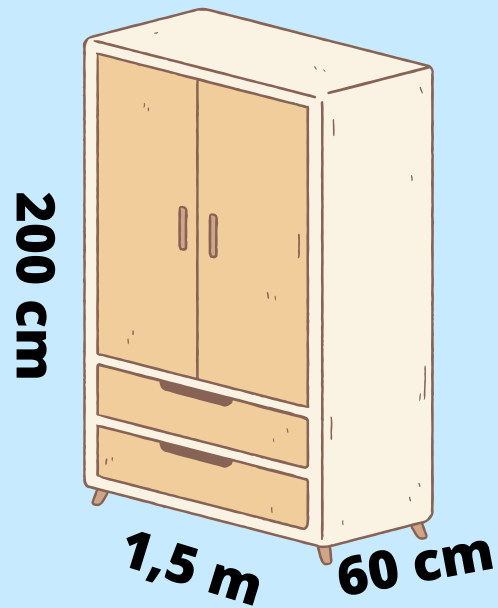

28. Wat is de inhoud van dit figuur?

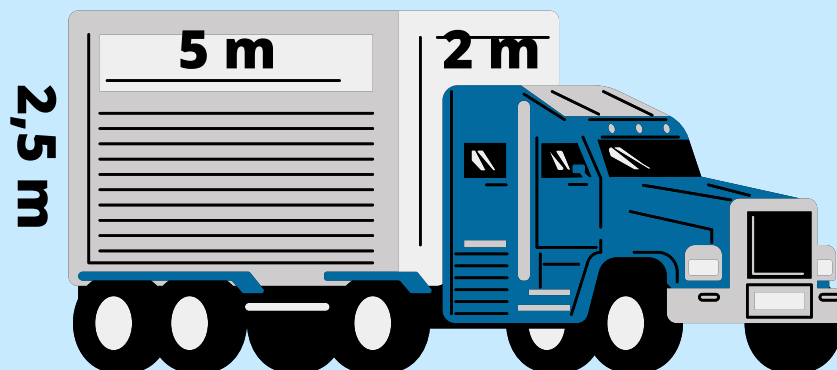

29. Wat is de inhoud van dit figuur?

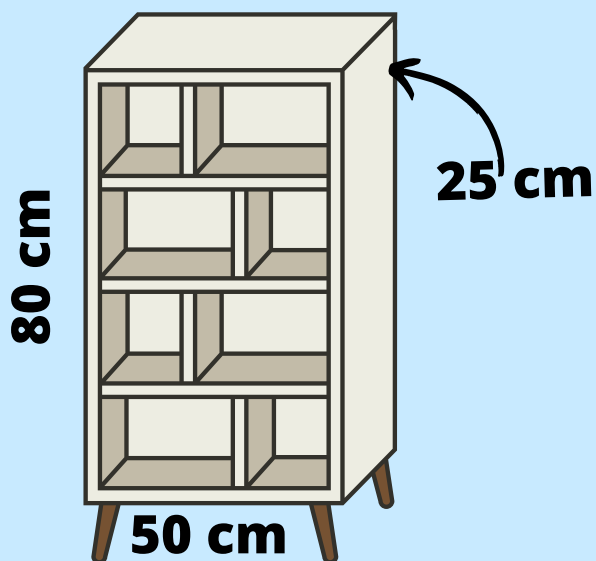

30. Wat is de inhoud van dit figuur?

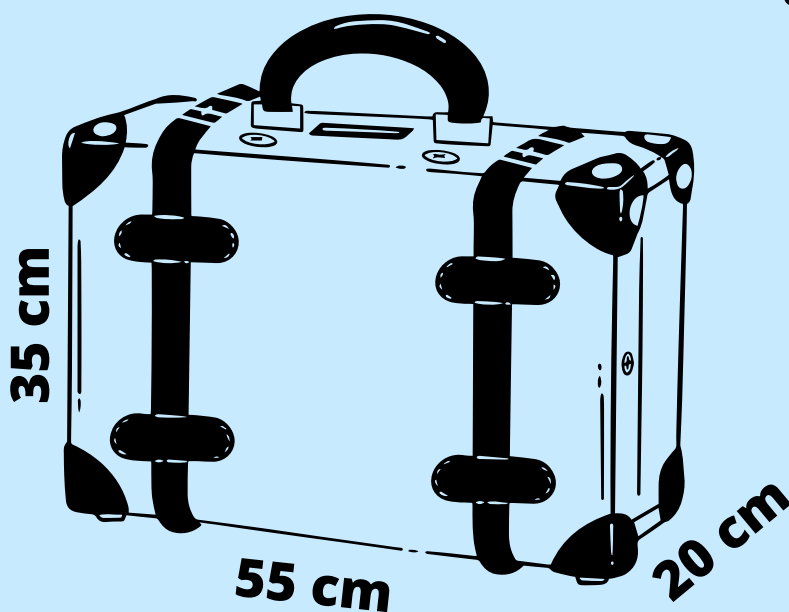

Antwoordblad

1		11	
2		12	
3		13	
4		14	
5		15	
6		16	
7		17	
8		18	
9		19	
10		20	

Antwoordblad

inhoud berekenen

21	
22	
23	
24	
25	
26	
27	
28	
29	
30	

Antwoordblad

1	35 cm²	11	12 dm²
2	24 cm	12	28 cm
3	23 cm²	13	5000 m²
4	16 cm	14	60 m
5	27 cm²	15	54 cm²
6	24 cm	16	12 cm²
7	16 cm²	17	28 cm²
8	22 cm	18	20 cm
9	30 m²	19	200 m²
10	24 m²	20	300 m

Antwoordblad

inhoud berekenen

21	64 cm³
22	72 m³
23	30 m³
24	84000 cm³
25	5000 cm³
26	18000 cm³
27	1800000 cm³ of 1,8 dm³
28	25 m³
29	100000 cm³
30	38500 cm³